

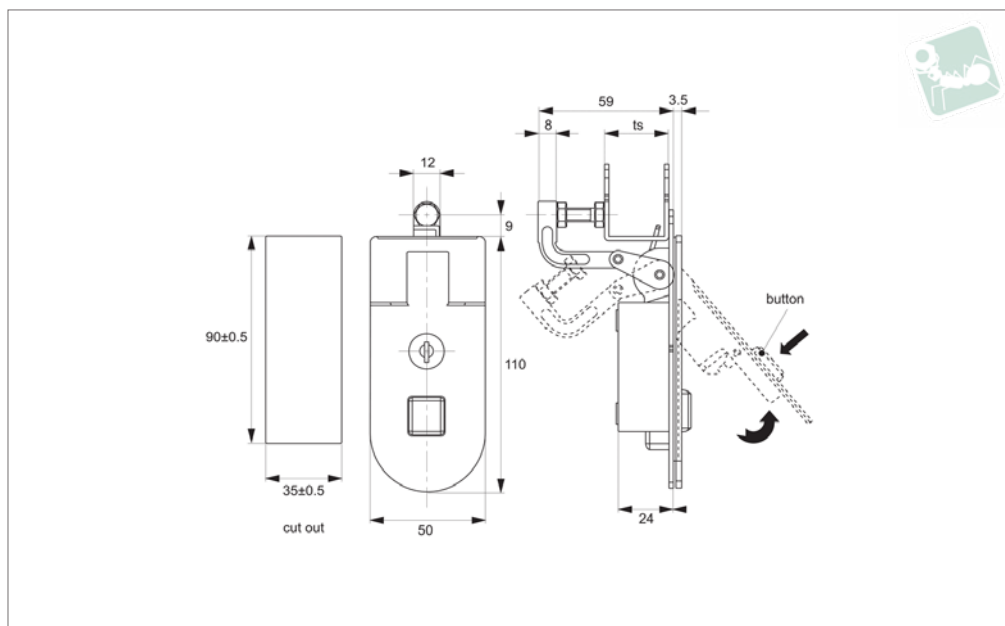

Compression Locks

lever latch - adjustable grip - zinc



CC1220

LOCKS

Material

Body and handle: die cast zinc, black power coated.
Cylinder lock: die cast zinc.
Screw: steel, white zinc plated.

Supplied with: KEY.

Technical Notes

Grip adjustment 31-48mm.

Tips

Quick-open, easy assembling. Grip length can be adjusted via clamping screw to suit your application.

Order No. CC1220.M0310	Finish Black Coated	Lock type Std. Cylinder	ts grip adj. 31-48
----------------------------------	------------------------	----------------------------	-----------------------



When selecting a Wixroyd Cam Latch for your application, you need to answer these questions:

1. Which installation cut out?
2. Which body style?
3. Which locking key?
4. Which accessories?
5. Which cam type and size?

Step 1: Which installation cut out?

Cut out

All our Flexi-System cam latches use a standard installation cut out 22,2 dia, 20,2 square, for maximum flexibility. We also provide a number of alternative cut out dimensions for legacy/historical installations.

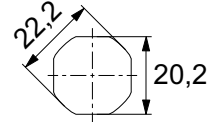

flexi-system cut out

Step 2: Which body style?

Material and finish

Select from our variety of die cast zinc, polyamide plastic and stainless versions.



Die-cast zinc chrome plate

Die-cast zinc black coated

Polyamide black

Stainless steel

Actuation and locking method

Standard insert driver type, cylinder lock or wing handle type.



Insert driver

Cylinder lock

Wing handle

Number of latching points in application

Typically single point latching is required, but the Wixroyd Flexi-System also provides multi-point latching (typically 3 point - at lock point, top and bottom of cabinet).



Single point

Two point

Multi-point

Step 3: Which locking key?

Standard insert driver keys

Our range of insert driver cam latches require a simple key to actuate. Refer to part A0102 and A0103 for correct keys.



Cylinder locking

Our cam locks with cylinder locks are supplied with two keys per lock. Available as keyed alike or keyed to differ locks.



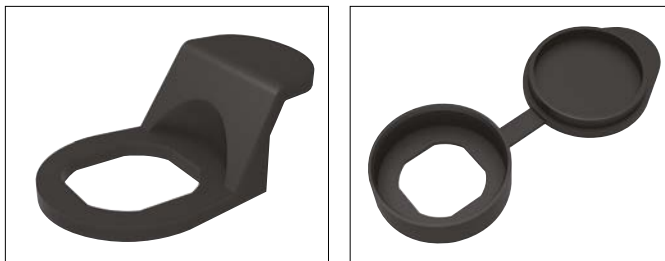

Step 4: Which accessories?

- Multi-point latching: use our rod set A0303 to A0325 for suitable rods and rod guides.
- Finger pulls: easily installed with any of our flexi-system cam bodies, finger pull no. A0352 is a simple, cost effective handle for your cabinets.
- Dust Cap: to reduce material ingress.







Miscellaneous Cut out	Actuation Method			Body length (mm)	Body			Finishes			Cam Type		
	Insert Driver	Cylinder Lock	Manual/Grip		Die-Cast Zinc	Polyamide Plastic	Stainless Steel	Chrome Plated	Black Coated	Natural	With Projection	W/O Projection	IP Rating
A1192 - Mini Cam Latch - Wing Handle - Fixed Grip													
		✓		10	✓			✓					
Cams: Supplied - Keys: N/A													
A1506 - Panel Latches - Fixed Grip													
	✓			25			✓		✓			54	
Cams: Supplied - Keys: A0102													
A1520 - Cam Lock - Fixed Grip													
	✓			18	✓				✓				
Cams: Supplied - Keys: A0102													
A1546 - Panel Latch - Uncovered													
		✓			✓			✓					
Cams: Supplied - Keys: N/A													
A1561 - Panel Latch - with Cover													
	✓			22,5	✓				✓				
Cams: Supplied - Keys: N/A													
A1701 - Compression Latch - Lever Latch - Flush Trigger													
	✓				✓			✓					
Cams: N/A - Keys: Supplied													
A1707 - Compression Latch - Lever Latch - Raised Trigger													
	✓			19	✓				✓				
Cams: Supplied - Keys: Supplied													
A1751 - Compression Latch - Lever Latch													
	✓				✓			✓					
Cams: N/A - Keys: Supplied													

Miscellaneous Cut out	Actuation Method			Body length (mm)	Body			Finishes			Cam Type		
	Insert Driver	Cylinder Lock	Manual/Grip		Die-Cast Zinc	Polyamide Plastic	Stainless Steel	Chrome Plated	Black Coated	Natural	With Projection	W/O Projection	IP Rating
A4241 - Cam Latch - with Rod Control - Extended Cover													
		✓				✓				✓		40	
Cams: A0203, A0224, A0240 - Keys: A0102													
A4260 - Cam Lock - with Rod Control - Wing Handle - Extended Cover													
		✓				✓				✓		54	
Cams: A0203, A0224, A0240 - Keys: A0102													
A4221 - Cam Latch - with Rod Control - with Cover													
		✓		Various		✓				✓		✓	
Cams: A0203, A0224 - Keys: A0102													

LOCKS



Miscellaneous Cut out	Actuation Method			Body length (mm)	Body			Finishes			Cam Type	
	Insert Driver	Cylinder Lock	Manual/Grip		Die-Cast Zinc	Polyamide Plastic	Stainless Steel	Chrome Plated	Black Coated	Natural	With Projection	W/O Projection
	✓			10	✓			✓				
A1192 - Mini Cam Latch - Wing Handle - Fixed Grip Cams: Supplied - Keys: N/A												
	✓			25		✓		✓			54	
A1506 - Panel Latches - Fixed Grip Cams: Supplied - Keys: A0102												
	✓			18		✓		✓				
A1520 - Cam Lock - Fixed Grip Cams: Supplied - Keys: A0102												
			✓			✓		✓				
A1546 - Panel Latch - Uncovered Cams: Supplied - Keys: N/A												
	✓			22,5		✓		✓				
A1561 - Panel Latch - with Cover Cams: Supplied - Keys: N/A												
	✓					✓		✓				
A1701 - Compression Latch - Lever Latch - Flush Trigger Cams: N/A - Keys: Supplied												
	✓			19		✓		✓				
A1707 - Compression Latch - Lever Latch - Raised Trigger Cams: Supplied - Keys: Supplied												
	✓					✓		✓				
A1751 - Compression Latch - Lever Latch Cams: N/A - Keys: Supplied												

Miscellaneous Cut out	Actuation Method			Body length (mm)	Body			Finishes			Cam Type	
	Insert Driver	Cylinder Lock	Manual/Grip		Die-Cast Zinc	Polyamide Plastic	Stainless Steel	Chrome Plated	Black Coated	Natural	With Projection	W/O Projection
	✓					✓		✓			✓	40
A4241 - Cam Latch - with Rod Control - Extended Cover Cams: A0203, A0224, A0240 - Keys: A0102												
		✓				✓		✓			✓	54
A4260 - Cam Lock - with Rod Control - Wing Handle - Extended Cover Cams: A0203, A0224, A0240 - Keys: A0102												
	✓			Various		✓		✓			✓	
A4221 - Cam Latch - with Rod Control - with Cover Cams: A0203, A0224 - Keys: A0102												